

Round LED High Bay 350-Watt 50,000 lumens

RHB Series LED High Bay Fixture

The RHB2-5-M-350 round high bay fixture delivers high lumen output with exceptional 82+CRI light while achieving 50,000 lumen output levels. The 120 degree lens guarantees light intensity and uniformity. The RHB2 Series round high bay fixture is designed to replace either HID or fluorescent high bay fixtures.

Aluminum Construction

The housing, consisting of aluminum finned material acts as an excellent heatsink channeling heat out and away from the LED's.

Electrical

Long-life Philips LED system delivers optimal performance. LED's available in 82+ CRI, 5000k. Projected LED life is greater than 50,000 hours. Fixture is cULus listed. Electronic drivers are available for 120- 277V and 347/480V applications.

Finish

Bronze power coated aluminum construction provides protection against contaminants and oxidation.

Optics

Precision designed optics deliver even illumination. General and aisle distribution ensures superior performance to key areas within an application. The tempered lens design allows maximum delivered lumens in any industrial or commercial environment while maintaining its wet location certification.



RHB2-5-M-350

Performance

The RHB2-5-M-350 luminaire offers:

- 142 lumens/watt
- CRI >80; THD <10%
- PF >99
- Projected LED life is greater than 50,000 hours

Electrical and Warranty

Fixture is standard with long life LED modules by Philips. LED modules and drivers are offered with a standard 5-year warranty based on performance under normal conditions (consult warranty for details).

Compliance

This fixture is UL listed and IP65 rated for wet locations and -40°C to +40°C ambient environments. DLC and RoHS compliant. LED modules comply with IESNA LM-79 and LM-80 standards.

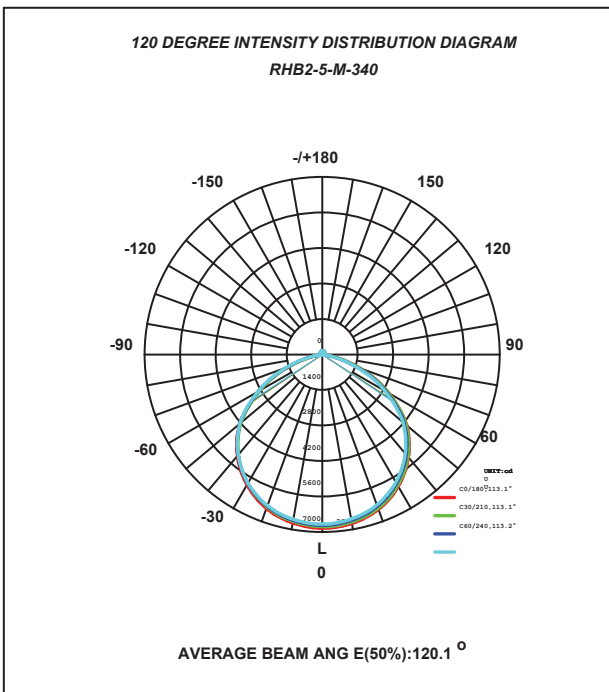

Dimensions

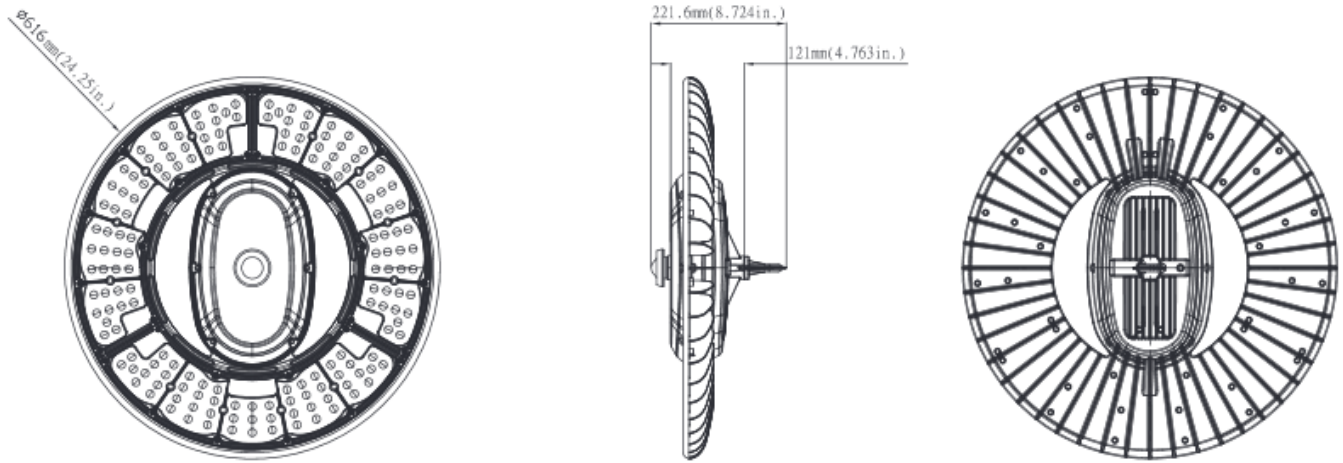

Weight:
200W/250W: 16.27lb
300W/340W: 17.57lb